



Description

DME PROLINK's Multi compartment enclosure allows two different users to access space within in the same footprint of a standard enclosure. Each compartment has its own front and rear access doors with locks as standard. There is a divider panel within the rack that separates the two compartments. This allows the facility manager to have access to each compartment, but each compartment has a dedicated use.

Features & Benefits

- Static loading capability of up to 1000 kg.
- Removable Side panels and Doors.
- Perforated Front and Rear door
- Bottom cable entry
- Optional : Fan Tray with 4 Fans / 2 Fans
- Optional: Standard 6-Way Power Distribution Unit (PDUs can be customized)
- Key Lock arrangement for added security for each compartment.
- 3 Point Locking system.
- Castors wheels / Leveling Feet
- Height (H): 42.5U
- Width (W): 800mm
- Depth (D): 800mm, 1200mm
- 25 Years System Warranty



Drawing

Free Standing 19" 42.5U W=800 mm D=800 mm; 2 compartment Co-location rack cabinet 12U + 0.5U Separator +30U , Total 42U usage space, with side cable trays, each compartment front and rear double perforated doors with 3 point locking system, Black

FRONT VIEW

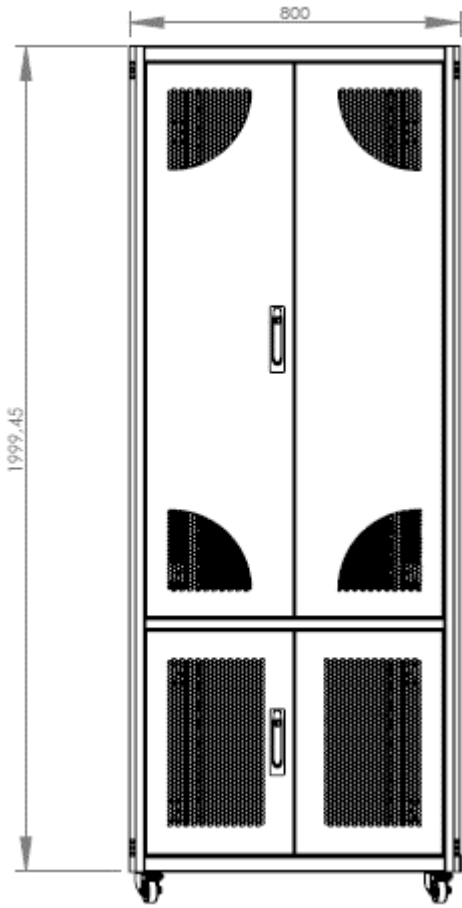

REAR VIEW

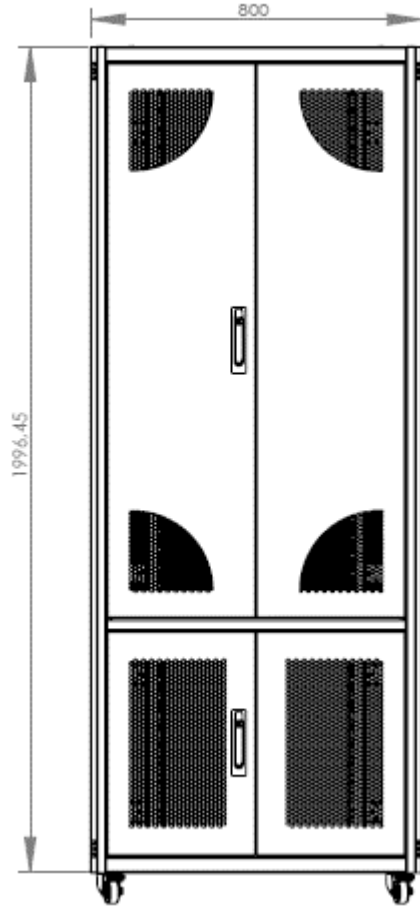

SIDE VIEW

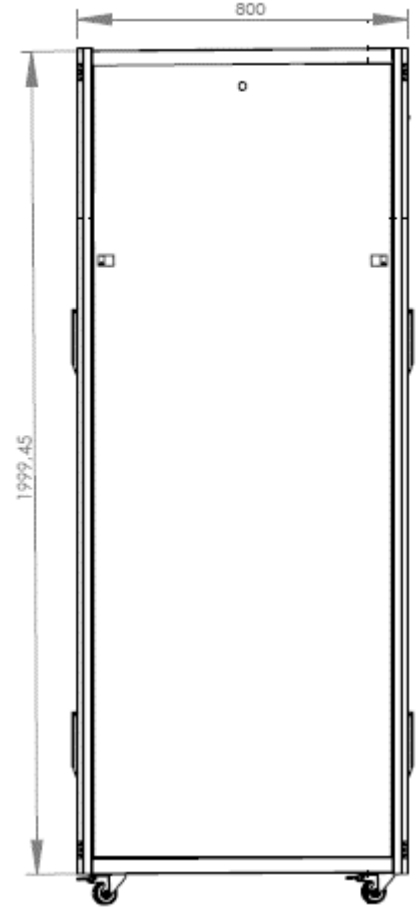

BOTTOM VIEW

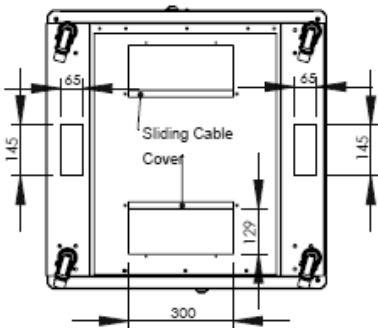

TOP VIEW

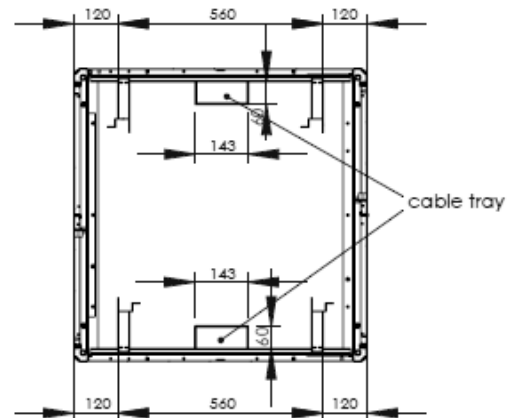
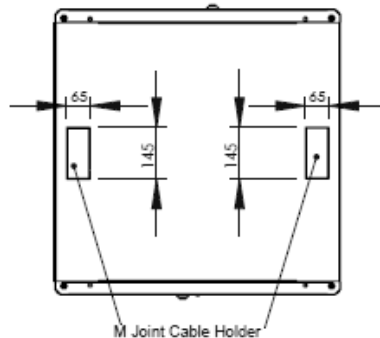

Drawing continued

Free Standing 19" 42.5U W=800 mm D=800 mm; 2 compartment Co-location rack cabinet 12U + 0.5U Separator +30U , Total 42U usage space, with side cable trays, each compartment front and rear double perforated doors with 3 point locking system, Black

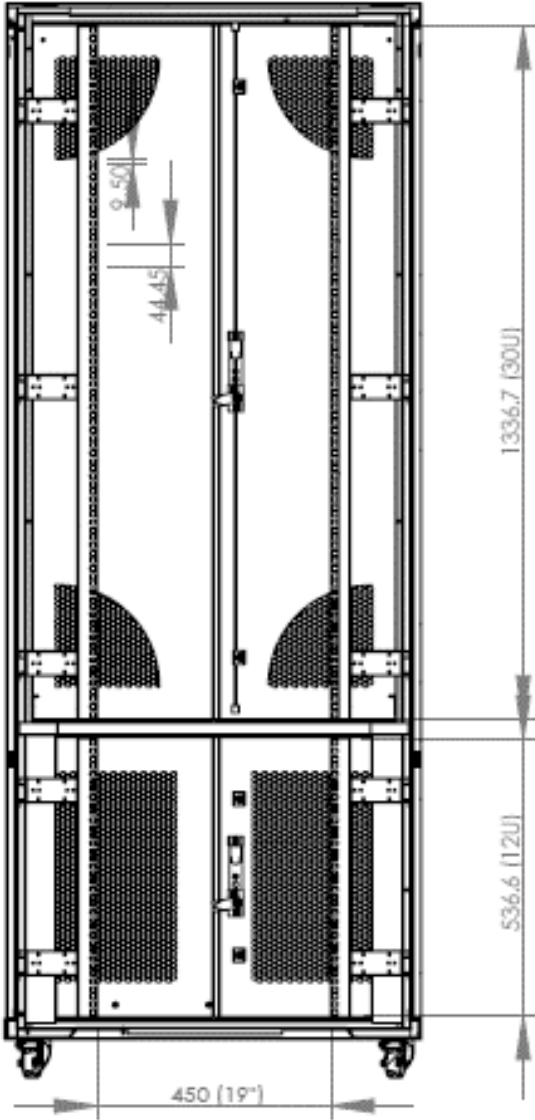

Drawing

Free Standing 19" 42.5U W=800 mm D=1200 mm 2 compartment Co-location rack cabinet 12U + 0.5U Separator +30U , total 42U usage , with side cable trays, each compartment front and rear double perforated doors with 3point locking system . With 3 set of mounting rails (front standard, middle U shape for shorter than 740mm devices , rear standard)

FRONT VIEW

REAR VIEW

SIDE VIEW

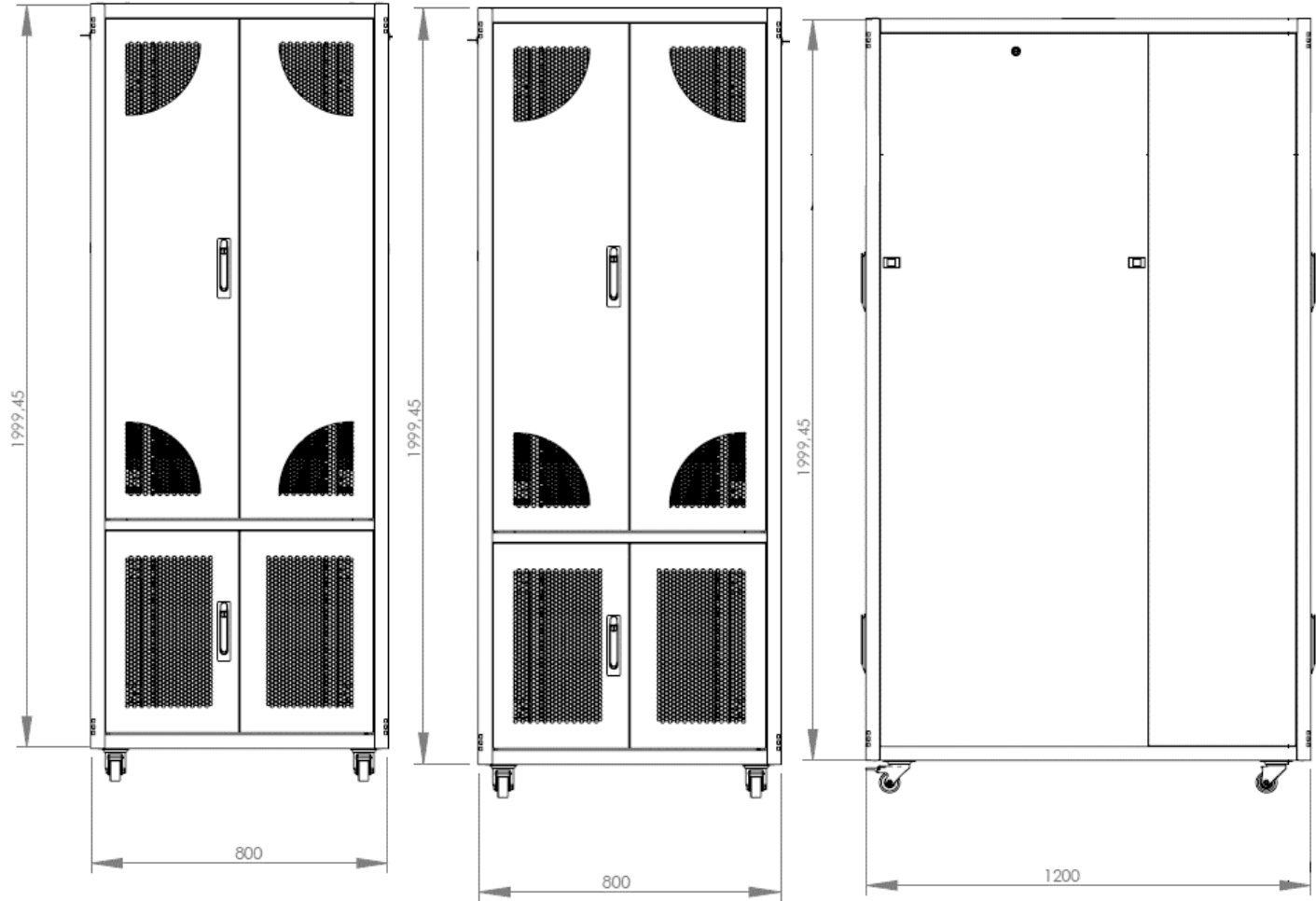

BOTTOM VIEW

TOP VIEW

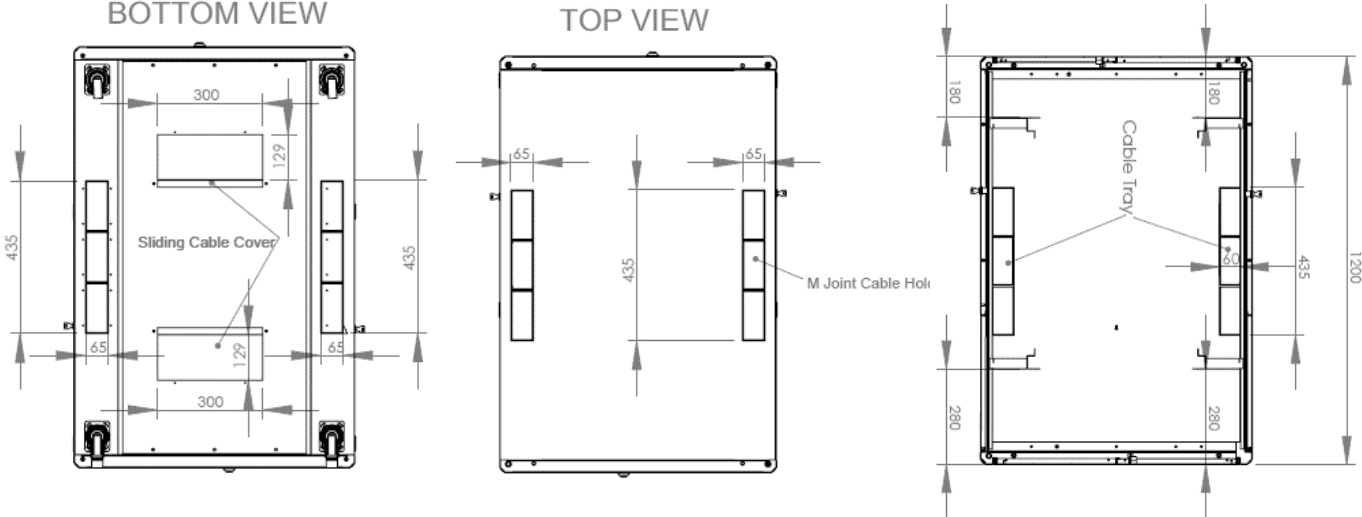

Drawing continued

Free Standing 19" 42.5U W=800 mm D=1200 mm 2 compartment Co-location rack cabinet 12U + 0.5U Separator +30U , total 42U usage , with side cable trays, each compartment front and rear double perforated doors with 3point locking system . With 3 set of mounting rails (front standard, middle U shape for shorter than 740mm devices , rear standard)

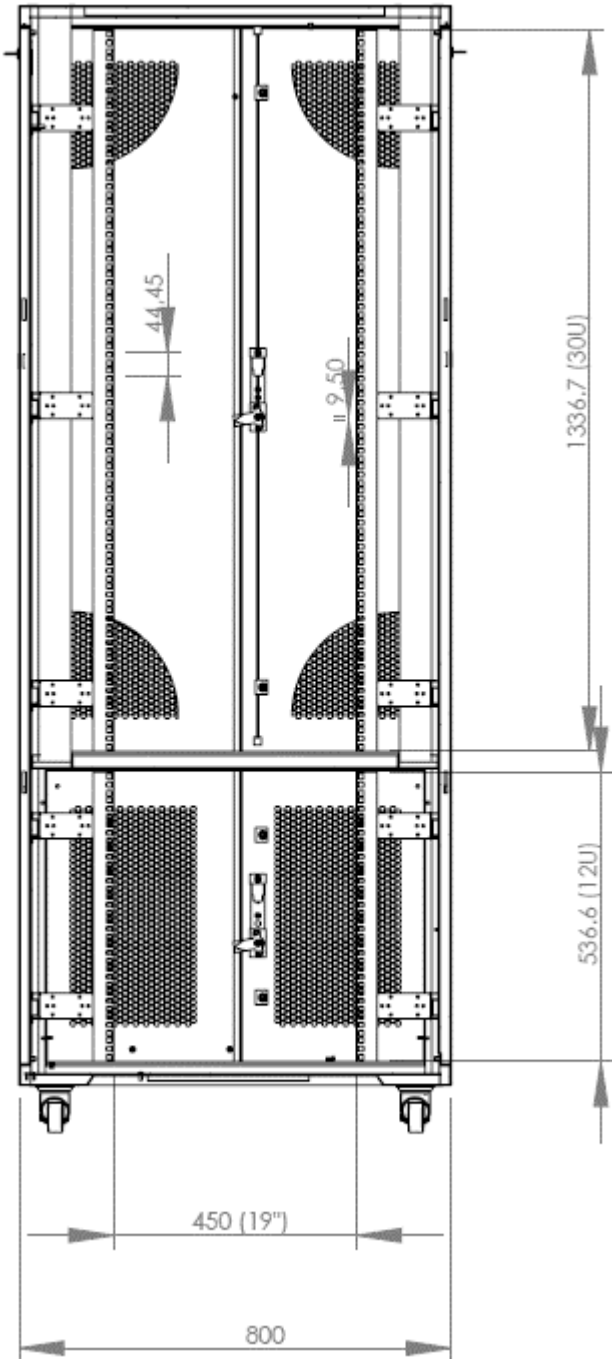

Part Number

D3219-428080000BK-G	Free Standing 19" 42.5U W=800 mm D=800 mm 2 compartment Co-location rack cabinet 12U + 0.5U Separator +30U , Total 42U usage space, with side cable trays, each compartment front and rear double perforated doors with 3 point locking system, Black
D3219-4280120000BK-G	Free Standing 19" 42.5U W=800 mm D=1200 mm 2 compartment Co-location rack cabinet 12U + 0.5U Separator +30U , total 42U usage , with side cable trays, each compartment front and rear double perforated doors with 3point locking system . With 3 set of mounting rails (front standard, middle U shape for shorter than 740mm devices , rear standard)
D63119-4FSCBK	DME Prolink Ventilation Unit with 4 fans with On/OFF Switch Control, Black
D63419-0.580BK	DME Prolink Shelf, 19", 0.5 RU, 800mm Deep, Black
D63719-M650	DME Prolink M6 Cage Nut Maxi Set (1 set=50pcs cage nut, screw and washer)
D631619-BK BK	DME Prolink Outer cabinet connection kit , Black
D632319-MLU	DME Prolink Magnetic lighting unit